

# Switch Amplifier

## KCD2-SR-Ex1.LB.SP

- 1-channel isolated barrier
- 24 V DC supply (Power Rail)
- Dry contact or NAMUR inputs
- Usable as signal splitter (1 input and 2 outputs)
- Relay contact output
- Fault relay contact output
- Line fault detection (LFD)
- Housing width 12.5 mm
- Connection via spring terminals with push-in connection technology
- Up to SIL 2 acc. to IEC/EN 61508



### Function

This isolated barrier is used for intrinsic safety applications. The device transfers digital signals from NAMUR sensors or dry contacts from the hazardous area to the non-hazardous area. The proximity sensor or the mechanical contact controls the control side load for a relay contact output. The device output changes the state when the input signal changes the state. Via switches the mode of operation can be reversed and the line fault detection can be switched off. During a fault condition, the relay reverts to its de-energized state and the LEDs indicate the fault according to NAMUR NE 44. If the device is operated via Power Rail, additionally a collective error message is available. Due to its compact housing design and low heat dissipation, this device is useful for detecting positions, end stops, and switching states in space-critical applications.

### Connection

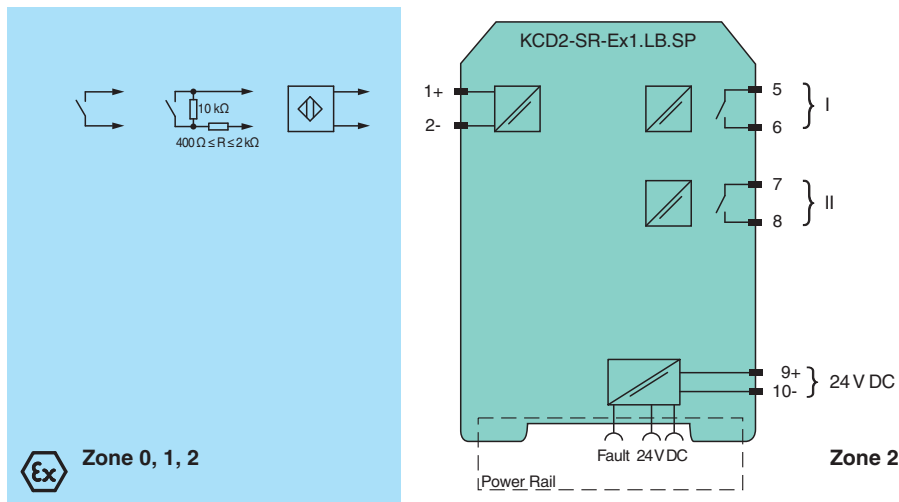

### Technical Data

<b>General specifications</b>	
Signal type	Digital Input
<b>Functional safety related parameters</b>	
Safety Integrity Level (SIL)	SIL 2
<b>Supply</b>	
Connection	Power Rail or terminals 9+, 10-
Rated voltage	U <sub>r</sub> 19 ... 30 V DC

Release date: 2022-01-10 Date of issue: 2022-01-10 Filename: 70112156\_eng.pdf

Refer to "General Notes Relating to Pepperl+Fuchs Product Information".

Pepperl+Fuchs Group  
www.pepperl-fuchs.com

USA: +1 330 486 0002  
pa-info@us.pepperl-fuchs.com

Germany: +49 621 776 2222  
pa-info@de.pepperl-fuchs.com

Singapore: +65 6779 9091  
pa-info@sg.pepperl-fuchs.com

**PEPPERL+FUCHS**

## Technical Data

Ripple		≤ 10 %
Rated current	$I_r$	≤ 37 mA
Power dissipation		≤ 750 mW
Power consumption		≤ 750 mW
<b>Input</b>		
Connection side		field side
Connection		terminals 1+, 2-
Rated values		acc. to EN 60947-5-6 (NAMUR)
Open circuit voltage/short-circuit current		approx. 8 V DC / approx. 8 mA
Switching point/switching hysteresis		1.2 ... 2.1 mA / approx. 0.2 mA
Line fault detection		breakage $I \leq 0.1$ mA , short-circuit $I \geq 6.5$ mA
Pulse/Pause ratio		min. 20 ms / min. 20 ms
<b>Output</b>		
Safety note		If load voltage > 50 V, de-energize before removing the terminals.
Connection side		control side
Connection		output I: terminals 5, 6 ; output II: terminals 7, 8
Output I		signal ; relay
Output II		signal or error message ; relay
Contact loading		250 V AC/2 A/cos $\phi > 0.75$ ; 126.5 V AC/4 A/cos $\phi > 0.75$ ; 30 V DC/2 A resistive load
Minimum switch current		2 mA / 24 V DC
Energized/De-energized delay		≤ 20 ms / ≤ 20 ms
Mechanical life		10 <sup>7</sup> switching cycles
<b>Transfer characteristics</b>		
Switching frequency		≤ 10 Hz
<b>Galvanic isolation</b>		
Input/Output		reinforced insulation according to IEC/EN 61010-1, rated insulation voltage 300 V <sub>eff</sub>
Input/power supply		reinforced insulation according to IEC/EN 61010-1, rated insulation voltage 300 V <sub>eff</sub>
Output/power supply		reinforced insulation according to IEC/EN 61010-1, rated insulation voltage 300 V <sub>eff</sub>
Output/Output		reinforced insulation according to IEC/EN 61010-1, rated insulation voltage 300 V <sub>eff</sub>
<b>Indicators/settings</b>		
Display elements		LEDs
Control elements		DIP switch
Configuration		via DIP switches
Labeling		space for labeling at the front
<b>Directive conformity</b>		
Electromagnetic compatibility		
Directive 2014/30/EU		EN 61326-1:2013 (industrial locations)
Low voltage		
Directive 2014/35/EU		EN 61010-1:2010+A1:2019+A1:2019/AC:2019
<b>Conformity</b>		
Electromagnetic compatibility		NE 21:2017 , EN 61326-3-1:2017 , EN IEC 61326-3-2:2018
Degree of protection		IEC 60529:1989+A1:1999+A2:2013
Functional safety		IEC/EN 61508:2010
Input		EN 60947-5-6:2000
<b>Ambient conditions</b>		
Ambient temperature		-40 ... 70 °C (-40 ... 158 °F)
<b>Mechanical specifications</b>		
Degree of protection		IP20
Connection		spring terminals
Mass		approx. 100 g
Dimensions		12.5 x 119 x 114 mm (0.5 x 4.7 x 4.5 inch) (W x H x D) , housing type A2
Mounting		on 35 mm DIN mounting rail acc. to EN 60715:2001
<b>Data for application in connection with hazardous areas</b>		

Release date: 2022-01-10 Date of issue: 2022-01-10 Filename: 70112156\_eng.pdf

## Technical Data





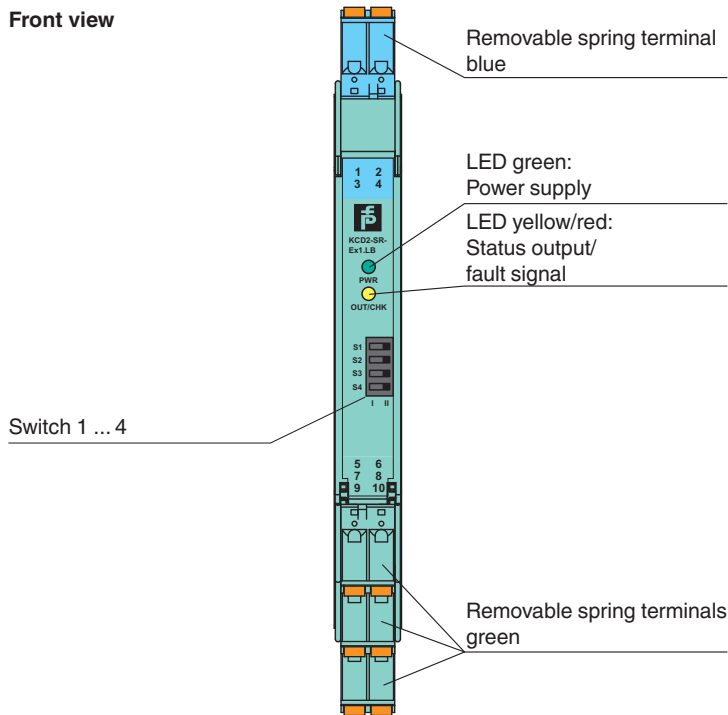

EU-type examination certificate		BASEEFA 06 ATEX 0092 X
Marking		Ⓜ II 3(1)G Ex ec nC [ia Ga] IIC T4 Gc , Ⓜ II (1)D [Ex ia Da] IIIC , Ⓜ I (M1) [Ex ia Ma] I
Input		Ex ia
Voltage	U <sub>o</sub>	10.5 V
Current	I <sub>o</sub>	13 mA
Power	P <sub>o</sub>	34 mW (linear characteristic)
Supply		
Maximum safe voltage	U <sub>m</sub>	253 V AC (Attention! U <sub>m</sub> is no rated voltage.)
Output		
Contact loading		Zone 2 : 50 V AC/2 A/cos φ > 0.75; 30 V DC/2 A resistive load
Maximum safe voltage	U <sub>m</sub>	253 V AC (Attention! The rated voltage can be lower.)
Fault indication output		
Maximum safe voltage	U <sub>m</sub>	40 V DC (Attention! U <sub>m</sub> is no rated voltage.)
Galvanic isolation		
Input/Output		safe electrical isolation acc. to IEC/EN 60079-11, voltage peak value 375 V
Input/power supply		safe electrical isolation acc. to IEC/EN 60079-11, voltage peak value 375 V
Directive conformity		
Directive 2014/34/EU		EN IEC 60079-0:2018 , EN 60079-7:2015+A1:2018 , EN 60079-11:2012 , EN IEC 60079-15:2019
<b>International approvals</b>		
UL approval		E106378
Control drawing		116-0477 (cULus)
<b>IECEX approval</b>		
IECEX certificate		IECEX BAS 06.0025 X
IECEX marking		Ex ec nC [ia Ga] IIC T4 Gc [Ex ia Da] IIIC [Ex ia Ma] I
<b>General information</b>		
Supplementary information		Observe the certificates, declarations of conformity, instruction manuals, and manuals where applicable. For information see <a href="http://www.pepperl-fuchs.com">www.pepperl-fuchs.com</a> .

## Assembly





Front view



## Matching System Components

	<b>KFD2-EB2</b>	Power Feed Module
	<b>UPR-03</b>	Universal Power Rail with end caps and cover, 3 conductors, length: 2 m
	<b>UPR-03-M</b>	Universal Power Rail with end caps and cover, 3 conductors, length: 1,6 m
	<b>UPR-03-S</b>	Universal Power Rail with end caps and cover, 3 conductors, length: 0.8 m
	<b>K-DUCT-BU</b>	Profile rail, wiring comb field side, blue
	<b>K-DUCT-BU-UPR-03</b>	Profile rail with UPR-03- * insert, 3 conductors, wiring comb field side, blue

## Accessories

	<b>F-NR3-Ex1</b>	NAMUR Resistor Network
	<b>KC-CTT-3GN2BU</b>	Terminal block for KC modules, 2-pin spring terminal, with test sockets
	<b>KC-CTT-5BU</b>	Terminal block for KC modules, 2-pin spring terminal, with test sockets, blue
	<b>KC-CTT-5GN</b>	Terminal block for KC modules, 2-pin spring terminal, with test sockets, green

Release date: 2022-01-10 Date of issue: 2022-01-10 Filename: 70112156\_eng.pdf

**Accessories**

	<b>KF-CP</b>	Red coding pins, packaging unit: 20 x 6
---	--------------	---

Release date: 2022-01-10 Date of issue: 2022-01-10 Filename: 70112156\_eng.pdf

Refer to "General Notes Relating to Pepperl+Fuchs Product Information".

Pepperl+Fuchs Group  
www.pepperl-fuchs.com

USA: +1 330 486 0002  
pa-info@us.pepperl-fuchs.com

Germany: +49 621 776 2222  
pa-info@de.pepperl-fuchs.com

Singapore: +65 6779 9091  
pa-info@sg.pepperl-fuchs.com

**Configuration**

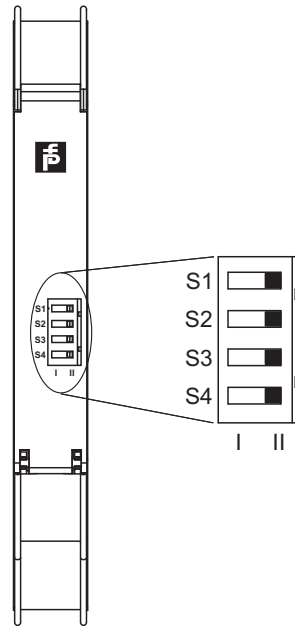

**Switch position**

S	Function	Position	
1	Mode of operation output I (relay) energized	with high input current	I
		with low input current	II
2	Assignment output II (relay)	Switching state like relay I	I
		Fault indication output (de-energized if fault)	II
3	Line fault detection	ON	I
		OFF	II
4	no function		

**Operating states**

Control circuit	Input signal
Initiator high impedance/contact opened	low input current
Initiator low impedance/contact closed	high input current
Lead breakage, lead short circuit	Line fault

Factory setting: switch 1, 2, 3 and 4 in position I

**Characteristic Curve**

**Maximum switching power of output contacts**

Release date: 2022-01-10 Date of issue: 2022-01-10 Filename: 70112156\_eng.pdf

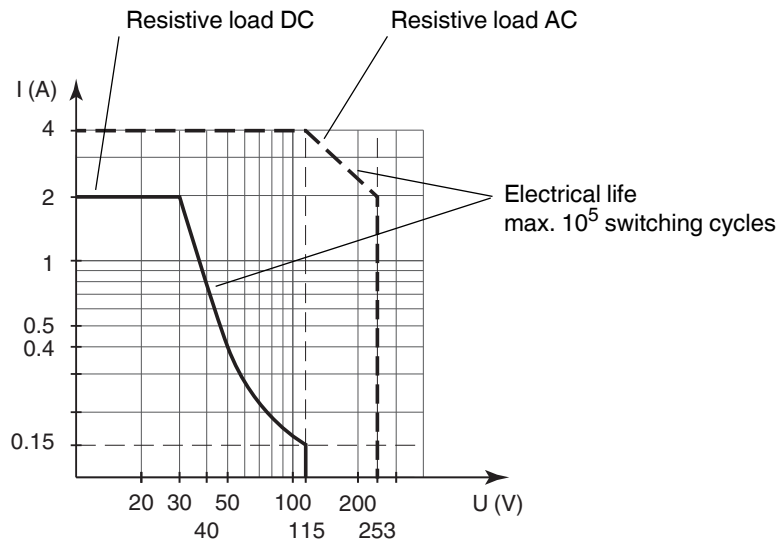

The maximum number of switching cycles is depending on the electrical load and may be higher when reduced currents and voltages are applied.