

# Frequency Converter with Trip Values

## KFU8-UFC-1.D.FA

- 1-channel signal conditioner
- Universal usage at different power supplies
- Input for 2- or 3-wire sensors, NAMUR sensors or dry contacts
- Input frequency 1 mHz ... 10 kHz
- Current output 0/4 mA ... 20 mA
- Relay contact and transistor output
- Start-up override
- Line fault detection (LFD)
- Up to SIL 2 acc. to IEC 61508/IEC 61511

# CE SIL2

## Function

This signal conditioner provides the isolation for non-intrinsically safe applications. The device is a universal frequency converter that changes a digital input signal into a proportional free adjustable 0/4 mA ... 20 mA analog output signal and functions as a switch amplifier and a trip alarm. The functions of the switch outputs (2 relay outputs and 1 potential free transistor output) are easily adjustable [trip value display (min/max alarm), serially switched output, pulse divider output, error signal output]. The device is easily configured by the use of keypad or with the PACTware configuration software. A fault is signaled by LEDs acc. to NAMUR NE44. For additional information, refer to the manual and [www.pepperl-fuchs.com](http://www.pepperl-fuchs.com).

## Connection

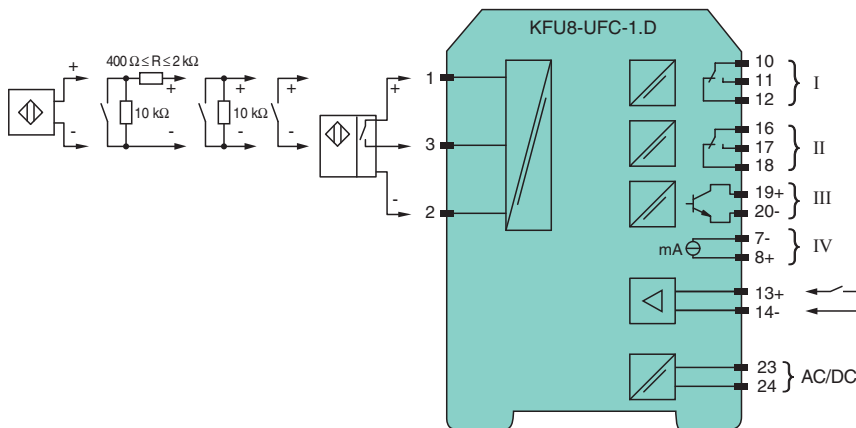

## Technical Data

### General specifications

Signal type Digital Input

### Functional safety related parameters

Safety Integrity Level (SIL) SIL 2

### Supply

Connection terminals 23, 24

Rated voltage  $U_r$  20 ... 90 V DC / 48 ... 253 V AC 50 ... 60 Hz

Power dissipation/power consumption  $\leq 2$  W ; 2.5 VA / 2.2 W ; 3 VA

### Interface

Release date: 2021-12-20 Date of issue: 2021-12-20 Filename: 282274\_eng.pdf

Refer to "General Notes Relating to Pepperl+Fuchs Product Information".

Pepperl+Fuchs Group  
www.pepperl-fuchs.com

USA: +1 330 486 0002  
pa-info@us.pepperl-fuchs.com

Germany: +49 621 776 2222  
pa-info@de.pepperl-fuchs.com

Singapore: +65 6779 9091  
pa-info@sg.pepperl-fuchs.com

**PEPPERL+FUCHS**

## Technical Data

Programming interface	programming socket
<b>Input</b>	
Connection side	field side
Connection	Input I: 2-wire sensor: terminals 1+, 3- three wire sensor: terminals 1+, 2- and 3 input II: terminals 13+, 14- start-up override;
Input I	2- or 3-wire sensor, sensor acc. to EN 60947-5-6 (NAMUR) or mechanical contact
Open circuit voltage/short-circuit current	22 V / 40 mA
Input resistance	4.7 k $\Omega$
Switching point/switching hysteresis	logic 1: > 2.5 mA ; logic 0: < 1.9 mA
Pulse duration	> 50 $\mu$ s
Input frequency	0.001 ... 10000 Hz
Line fault detection	breakage I $\leq$ 0.15 mA; short-circuit I > 4 mA
Input II	startup override: 1 ... 1000 s, adjustable in steps of 1 s
Active/Passive	I > 4 mA (for min. 100 ms) / I < 1.5 mA
Open circuit voltage/short-circuit current	18 V / 5 mA
<b>Output</b>	
Connection side	control side
Connection	output I: terminals 10, 11, 12 output II: terminals 16, 17, 18 output III: terminals 19+, 20- output IV: terminals 8+, 7-
Output I, II	signal, relay
Contact loading	250 V AC / 2 A / $\cos \phi \geq 0.7$ ; 40 V DC / 2 A
Mechanical life	5 x 10 <sup>7</sup> switching cycles
Energized/De-energized delay	approx. 20 ms / approx. 20 ms
Output III	electronic output, passive
Contact loading	40 V DC
Signal level	1-signal: (L+) -2.5 V (50 mA, short-circuit/overload proof) 0-signal: blocked output (off-state current $\leq$ 10 $\mu$ A)
Output IV	analog
Current range	0 ... 20 mA or 4 ... 20 mA
Open loop voltage	max. 24 V DC
Load	max. 650 $\Omega$
Fault signal	downscale I $\leq$ 3.6 mA , upscale $\geq$ 21.5 mA (acc. NAMUR NE43)
<b>Transfer characteristics</b>	
Input I	
Measurement range	0.001 ... 10000 Hz
Resolution	0.1 % of the measurement value , $\geq$ 0.001 Hz
Accuracy	0.1 % of the measurement value , > 0.001 Hz
Measuring time	< 100 ms
Influence of ambient temperature	0.003 %/K (30 ppm)
Output I, II	
Response delay	$\leq$ 200 ms
Output IV	
Resolution	< 10 $\mu$ A
Accuracy	< 20 $\mu$ A
Influence of ambient temperature	0.005 %/K (50 ppm)
<b>Galvanic isolation</b>	
Input I/other circuits	reinforced insulation according to IEC/EN 61010-1, rated insulation voltage 300 V <sub>eff</sub>
Output I, II/other circuits	reinforced insulation according to IEC/EN 61010-1, rated insulation voltage 300 V <sub>eff</sub>
Mutual output I, II, III	reinforced insulation according to IEC/EN 61010-1, rated insulation voltage 300 V <sub>eff</sub>
Output III/power supply	reinforced insulation according to IEC/EN 61010-1, rated insulation voltage 300 V <sub>eff</sub>
Output III/IV	basic insulation according to IEC/EN 61010-1, rated insulation voltage 50 V <sub>eff</sub>
Output IV/power supply	reinforced insulation according to IEC/EN 61010-1, rated insulation voltage 300 V <sub>eff</sub>
Start-up override/power supply	reinforced insulation according to IEC/EN 61010-1, rated insulation voltage 300 V <sub>eff</sub>

Release date: 2021-12-20 Date of issue: 2021-12-20 Filename: 282274\_eng.pdf

Refer to "General Notes Relating to Pepperl+Fuchs Product Information".

 Pepperl+Fuchs Group  
www.pepperl-fuchs.com

 USA: +1 330 486 0002  
pa-info@us.pepperl-fuchs.com

 Germany: +49 621 776 2222  
pa-info@de.pepperl-fuchs.com

 Singapore: +65 6779 9091  
pa-info@sg.pepperl-fuchs.com

 **PEPPERL+FUCHS**

**Technical Data**

Interface/power supply	reinforced insulation according to IEC/EN 61010-1, rated insulation voltage 300 V <sub>eff</sub>
Interface/output III	basic insulation according to IEC/EN 61010-1, rated insulation voltage 50 V <sub>eff</sub>
<b>Indicators/settings</b>	
Display elements	LEDs , display
Control elements	Control panel
Configuration	via operating buttons via PACTware
Labeling	space for labeling at the front
<b>Directive conformity</b>	
Electromagnetic compatibility	
Directive 2014/30/EU	EN 61326-1:2006
Low voltage	
Directive 2014/35/EU	EN 61010-1:2010
<b>Conformity</b>	
Electromagnetic compatibility	NE 21:2006
Degree of protection	IEC 60529:2001
<b>Ambient conditions</b>	
Ambient temperature	-20 ... 60 °C (-4 ... 140 °F)
<b>Mechanical specifications</b>	
Degree of protection	IP20
Connection	screw terminals
Mass	300 g
Dimensions	40 x 119 x 115 mm (1.6 x 4.7 x 4.5 inch) (W x H x D) , housing type C2
Mounting	on 35 mm DIN mounting rail acc. to EN 60715:2001
<b>General information</b>	
Supplementary information	Observe the certificates, declarations of conformity, instruction manuals, and manuals where applicable. For information see <a href="http://www.pepperl-fuchs.com">www.pepperl-fuchs.com</a> .



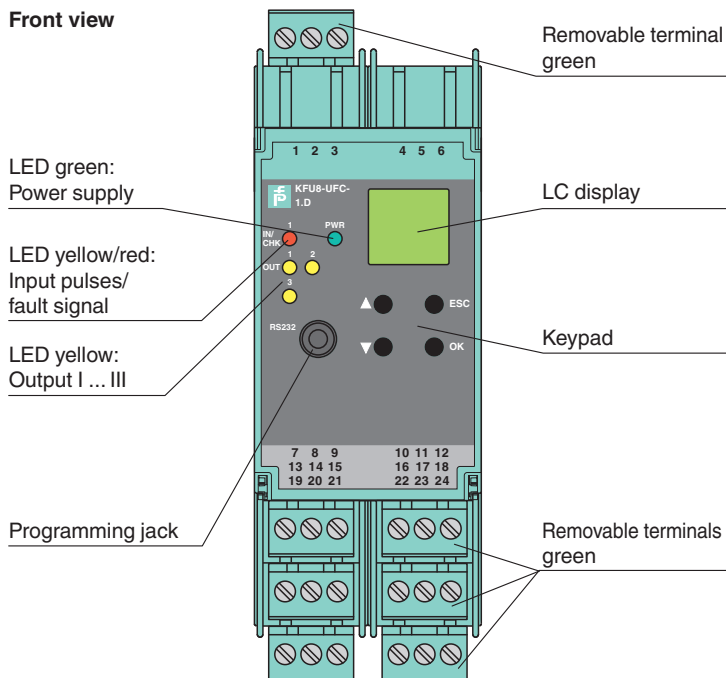

**Assembly**







Release date: 2021-12-20 Date of issue: 2021-12-20 Filename: 282274\_eng.pdf

Refer to "General Notes Relating to Pepperl+Fuchs Product Information".

### Matching System Components

	<b>DTM Interface Technology</b>	Device type manager (DTM) for interface technology
	<b>PACTware 5.X</b>	FDT Framework
	<b>K-ADP-USB</b>	Programming adapter with USB interface
	<b>K-DUCT-GY</b>	Profile rail, wiring comb field side, gray

### Accessories

	<b>K-250R</b>	Measuring resistor
	<b>K-500R0%1</b>	Measuring resistor
	<b>KF-ST-5GN</b>	Terminal block for KF modules, 3-pin screw terminal, green
	<b>KF-CP</b>	Red coding pins, packaging unit: 20 x 6

Release date: 2021-12-20 Date of issue: 2021-12-20 Filename: 282274\_eng.pdf

Refer to "General Notes Relating to Pepperl+Fuchs Product Information".

Pepperl+Fuchs Group  
www.pepperl-fuchs.com

USA: +1 330 486 0002  
pa-info@us.pepperl-fuchs.com

Germany: +49 621 776 2222  
pa-info@de.pepperl-fuchs.com

Singapore: +65 6779 9091  
pa-info@sg.pepperl-fuchs.com