

# Frequency Converter with Direction and Synchronization Monitor

## KFD2-UFT-Ex2.D

- 2-channel isolated barrier
- 24 V DC supply (Power Rail)
- Dry contact or NAMUR inputs
- Input frequency 1 mHz ... 1 kHz
- Current output 0/4 mA ... 20 mA
- Relay contact and transistor output
- Start-up override
- Configurable by PACTware or keypad
- Line fault detection (LFD)



### Function

This isolated barrier is used for intrinsic safety applications. It analyzes 2 digital signals (NAMUR sensor/mechanical contact) from a hazardous area and functions as a rotation direction indicator, slip monitor, frequency monitor or synchronization monitor. Each proximity sensor or switch controls a passive transistor output. The 2 relay outputs indicate if the input signal is above or below the trip value or the rotational direction. The analog output can be programmed to be proportional to the input frequency or slip differential. The unit is easily programmed by the use of a keypad located on the front of the unit or with the PACTware™ configuration software. Line fault detection of the field current is indicated by a red LED. For additional information, refer to the manual and [www.pepperl-fuchs.com](http://www.pepperl-fuchs.com).

### Connection

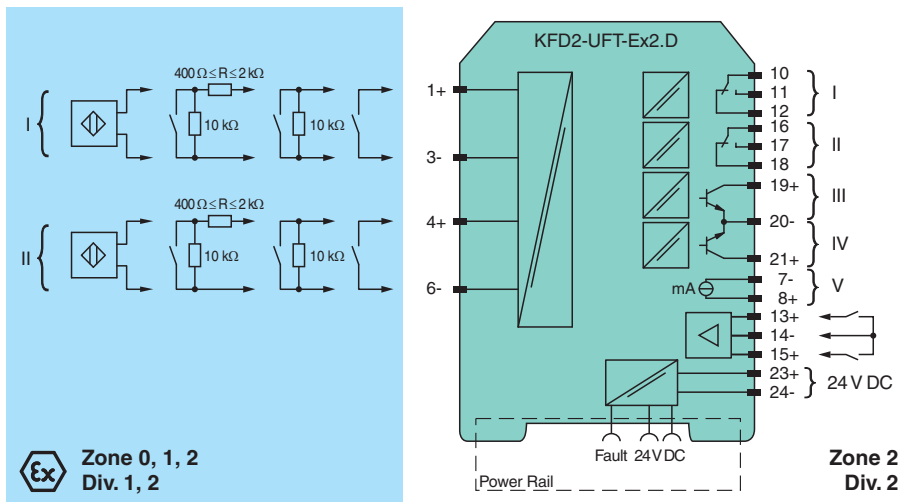

### Technical Data

#### General specifications

Signal type	Digital Input		
<b>Supply</b>			
Connection	terminals 23+, 24- or power feed module/Power Rail		
Rated voltage	$U_r$	20 ... 30 V DC	
Rated current	$I_r$	approx. 130 mA	
Power dissipation	2.2 W		
Power consumption	2.5 W		

Release date: 2022-01-10 Date of issue: 2022-01-10 Filename: 231200\_eng.pdf

Refer to "General Notes Relating to Pepperl+Fuchs Product Information".

Pepperl+Fuchs Group  
www.pepperl-fuchs.com

USA: +1 330 486 0002  
pa-info@us.pepperl-fuchs.com

Germany: +49 621 776 2222  
pa-info@de.pepperl-fuchs.com

Singapore: +65 6779 9091  
pa-info@sg.pepperl-fuchs.com

**PF** PEPPERL+FUCHS

## Technical Data

<b>Interface</b>	
Programming interface	programming socket
<b>Input</b>	
Connection side	field side
Connection	input I: terminals 1+, 3- input II: terminals 4+, 6- input III: terminals 13+, 14- (control input 1) input IV: terminals 15+, 14- (control input 2)
Input I, II	2-wire sensor, sensor acc. to EN 60947-5-6 (NAMUR) or mechanical contact
Open circuit voltage/short-circuit current	8.2 V / 10 mA
Pulse duration	min. 250 $\mu$ s , overlap on direction of rotation signal: $\geq$ 125 $\mu$ s
Input frequency	rotation direction monitoring 0.001 ... 1000 Hz slip monitoring 10 ... 1000 Hz
Line fault detection	breakage I $\leq$ 0.15 mA; short-circuit I $>$ 6.5 mA
Input III, IV	
Active/Passive	I $>$ 4 mA (for min. 100 ms) / I $<$ 1.5 mA
Open circuit voltage/short-circuit current	18 V / 5 mA
<b>Output</b>	
Connection side	control side
Connection	output I: terminals 10, 11, 12 output II: terminals 16, 17, 18 output III: terminals 19+, 20- output IV: terminals 21+, 20- output V: terminals 7-, 8+
Output I, II	signal , relay
Contact loading	253 V AC / 2 A / $\cos \phi \geq 0.7$ ; 40 V DC / 2 A
Mechanical life	5 x 10 <sup>7</sup> switching cycles
Energized/De-energized delay	approx. 20 ms / approx. 20 ms
Output III and IV	signal , electronic output, passive
Contact loading	40 V DC
Signal level	1-signal: (external voltage) - 2.5 V max. for 10 mA or 3 V max. for 100 mA (100 mA, short-circuit proof) -2.5 V (50 mA, short-circuit/overload proof) 0-signal: switched off (off-state current $\leq$ 10 $\mu$ A)
Output V	analog
Current range	0 ... 20 mA or 4 ... 20 mA
Open loop voltage	max. 24 V DC
Load	max. 650 $\Omega$
Fault signal	downscale I $\leq$ 3.6 mA, upscale I $\geq$ 21.5 mA (acc. NAMUR NE43)
Collective error message	Power Rail
<b>Transfer characteristics</b>	
Input I and II	
Measurement range	0.001 ... 1000 Hz
Resolution	slip monitoring: 1% frequency measurement: 0,1% of measured value; but $>$ 0.001Hz
Accuracy	slip monitoring: 1% frequency measurement: 0.5% of measured value; but $>$ 0.001Hz
Measuring time	frequency measurement: $<$ 100 ms
Influence of ambient temperature	0.003 %/K (30 ppm)
Output I, II	
Response delay	$\leq$ 200 ms
Output V	
Resolution	$<$ 10 $\mu$ A
Accuracy	$<$ 30 $\mu$ A
Influence of ambient temperature	0.005 %/K (50 ppm)
<b>Galvanic isolation</b>	
Input I, II/other circuits	reinforced insulation according to IEC/EN 61010-1, rated insulation voltage 300 V <sub>eff</sub>
Input III, IV/power supply and collective error	functional insulation acc. to IEC 62103, rated insulation voltage 50 V <sub>eff</sub>
Output I, II/other circuits	reinforced insulation according to IEC/EN 61010-1, rated insulation voltage 300 V <sub>eff</sub>
Mutual output I, II, III	reinforced insulation according to IEC/EN 61010-1, rated insulation voltage 300 V <sub>eff</sub>

Release date: 2022-01-10 Date of issue: 2022-01-10 Filename: 231200\_eng.pdf

Refer to "General Notes Relating to Pepperl+Fuchs Product Information".

Pepperl+Fuchs Group  
www.pepperl-fuchs.comUSA: +1 330 486 0002  
pa-info@us.pepperl-fuchs.comGermany: +49 621 776 2222  
pa-info@de.pepperl-fuchs.comSingapore: +65 6779 9091  
pa-info@sg.pepperl-fuchs.com

**PEPPERL+FUCHS**

## Technical Data

Mutual output I, II, IV		reinforced insulation according to IEC/EN 61010-1, rated insulation voltage 300 V <sub>eff</sub>
Output III, IV/power supply and collective error		basic insulation according to IEC/EN 61010-1, rated insulation voltage 50 V <sub>eff</sub>
Output III, IV/input III, IV		basic insulation according to IEC/EN 61010-1, rated insulation voltage 50 V <sub>eff</sub>
Output III, IV/V		basic insulation according to IEC/EN 61010-1, rated insulation voltage 50 V <sub>eff</sub>
Output V/power supply and collective error		functional insulation acc. to IEC 62103, rated insulation voltage 50 V <sub>eff</sub>
Interface/power supply and collective error		functional insulation acc. to IEC 62103, rated insulation voltage 50 V <sub>eff</sub>
Interface/output III, IV		basic insulation according to IEC/EN 61010-1, rated insulation voltage 50 V <sub>eff</sub>
<b>Indicators/settings</b>		
Display elements		LEDs , display
Control elements		Control panel
Configuration		via operating buttons via PACTware
Labeling		space for labeling at the front
<b>Directive conformity</b>		
Electromagnetic compatibility		
Directive 2014/30/EU		EN 61326-1:2013 (industrial locations)
Low voltage		
Directive 2014/35/EU		EN 61010-1:2010
<b>Conformity</b>		
Electromagnetic compatibility		NE 21:2006
Degree of protection		IEC 60529:2001
Input		EN 60947-5-6:2000
<b>Ambient conditions</b>		
Ambient temperature		-20 ... 60 °C (-4 ... 140 °F)
<b>Mechanical specifications</b>		
Degree of protection		IP20
Connection		screw terminals
Mass		300 g
Dimensions		40 x 119 x 115 mm (1.6 x 4.7 x 4.5 inch) (W x H x D) , housing type C2
Mounting		on 35 mm DIN mounting rail acc. to EN 60715:2001
<b>Data for application in connection with hazardous areas</b>		
EU-type examination certificate		TÜV 99 ATEX 1471
Marking		Ⓜ II (1)G [Ex ia Ga] IIC Ⓜ II (1)D [Ex ia Da] IIIC Ⓜ I (M1) [Ex ia Ma] I
<b>Supply</b>		
Maximum safe voltage	U <sub>m</sub>	40 V DC (Attention! U <sub>m</sub> is no rated voltage.)
Input I and II		terminals 1+, 3-, 4+, 6-: Ex ia
Voltage U <sub>o</sub>		10.1 V
Current I <sub>o</sub>		13.5 mA
Power P <sub>o</sub>		34 mW (linear characteristic)
Input III and IV		terminals 13+, 14-, 15+, 14- non-intrinsically safe
Maximum safe voltage U <sub>m</sub>		40 V (Attention! U <sub>m</sub> is no rated voltage.)
Output I, II		terminals 10, 11, 12; 16, 17, 18 non-intrinsically safe
Maximum safe voltage	U <sub>m</sub>	253 V (Attention! The rated voltage can be lower.)
Contact loading		253 V AC/2 A/cos φ > 0.7; 40 V DC/2 A resistive load
Output III and IV		terminals 19, 20, 21 non-intrinsically safe
Maximum safe voltage U <sub>m</sub>	U <sub>m</sub>	40 V DC (Attention! U <sub>m</sub> is no rated voltage.)
Output V		terminals 8+, 7- non-intrinsically safe
Maximum safe voltage U <sub>m</sub>	U <sub>m</sub>	40 V DC (Attention! U <sub>m</sub> is no rated voltage.)
Interface		RS 232
Maximum safe voltage	U <sub>m</sub>	40 V (Attention! U <sub>m</sub> is no rated voltage.)
Certificate		TÜV 02 ATEX 1885 X

Release date: 2022-01-10 Date of issue: 2022-01-10 Filename: 231200\_eng.pdf

Refer to "General Notes Relating to Pepperl+Fuchs Product Information".

Pepperl+Fuchs Group  
www.pepperl-fuchs.comUSA: +1 330 486 0002  
pa-info@us.pepperl-fuchs.comGermany: +49 621 776 2222  
pa-info@de.pepperl-fuchs.comSingapore: +65 6779 9091  
pa-info@sg.pepperl-fuchs.com

**PEPPERL+FUCHS**



## Technical Data

Marking	Ⓔ II 3G Ex nA nC IIC T4 Gc
Output I, II	
Contact loading	50 V AC/2 A/cos $\phi > 0.7$ ; 40 V DC/2 A resistive load
Galvanic isolation	
Input I, II/other circuits	safe electrical isolation acc. to IEC/EN 60079-11, voltage peak value 375 V
Directive conformity	
Directive 2014/34/EU	EN 60079-0:2012+A11:2013, EN 60079-11:2012, EN 60079-15:2010
<b>International approvals</b>	
FM approval	
Control drawing	16-538FM-12
UL approval	E223772
IECEX approval	
IECEX certificate	IECEX TUN 04.0007 IECEX TSA 18.0007X
IECEX marking	[Ex ia Ga] IIC, [Ex ia Da] IIIC, [Ex ia Ma] I Ex ec nC IIC T4 Gc
<b>General information</b>	
Supplementary information	Observe the certificates, declarations of conformity, instruction manuals, and manuals where applicable. For information see <a href="http://www.pepperl-fuchs.com">www.pepperl-fuchs.com</a> .

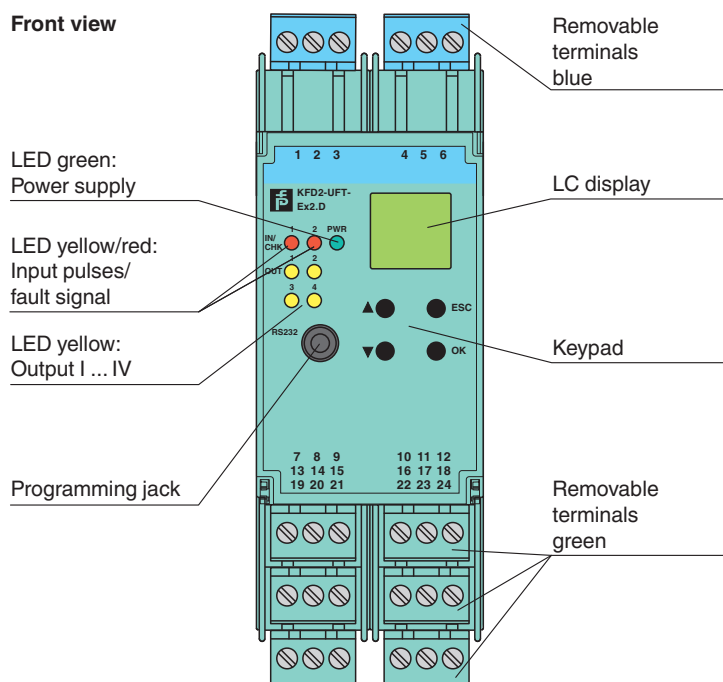





## Assembly









## Matching System Components

	<b>DTM Interface Technology</b>	Device type manager (DTM) for interface technology
	<b>PACTware 5.X</b>	FDT Framework
	<b>K-ADP-USB</b>	Programming adapter with USB interface

## Matching System Components

	<b>KFD2-EB2</b>	Power Feed Module
	<b>UPR-03</b>	Universal Power Rail with end caps and cover, 3 conductors, length: 2 m
	<b>UPR-03-M</b>	Universal Power Rail with end caps and cover, 3 conductors, length: 1,6 m
	<b>UPR-03-S</b>	Universal Power Rail with end caps and cover, 3 conductors, length: 0.8 m
	<b>K-DUCT-BU</b>	Profile rail, wiring comb field side, blue
	<b>K-DUCT-BU-UPR-03</b>	Profile rail with UPR-03- * insert, 3 conductors, wiring comb field side, blue

## Accessories

	<b>F-NR3-Ex1</b>	NAMUR Resistor Network
	<b>K-250R</b>	Measuring resistor
	<b>K-500R0%1</b>	Measuring resistor
	<b>KF-ST-5GN</b>	Terminal block for KF modules, 3-pin screw terminal, green
	<b>KF-ST-5BU</b>	Terminal block for KF modules, 3-pin screw terminal, blue
	<b>KF-CP</b>	Red coding pins, packaging unit: 20 x 6

**Operation**

The device processes two input frequencies up to a max. of 1 kHz. The following functions are provided by the device:

- Frequency measurement with freely adjustable trip value monitoring for high and low alarm as well as for frequency-current-conversion (0/4 mA ... 20 mA)
- Slip monitoring: The slip is calculated from the two input frequencies at channel I and II. If the freely parameterisable trip value is exceeded, the respective output switches.
- Rotation direction signalling: The rotation direction is evaluated from the two input signals with the same frequency and a phase shift of 90°. The corresponding outputs switch according to the direction of rotation.
- The frequency monitoring can be used in combination with rotation direction signalling or slip monitoring.
- Synchronisation monitor: The synchronisation monitor compares the pulse counts of the two inputs. If the measured difference in the pulses is greater than the programmed value the corresponding outputs are switching.

The two electronic outputs serve to repeat the input signals.

**Characteristic Curve**

**Maximum Switching Power of Output Contacts**

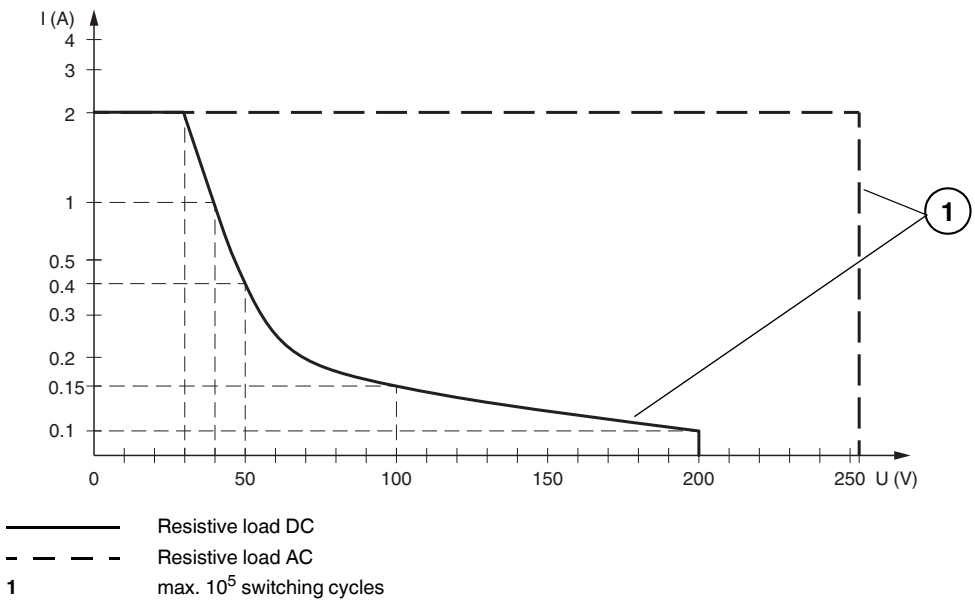

Release date: 2022-01-10 Date of issue: 2022-01-10 Filename: 231200\_eng.pdf

Refer to "General Notes Relating to Pepperl+Fuchs Product Information".