

Voltage Repeater KFD2-VR4-Ex1.26

- 1-channel isolated barrier
- 24 V DC supply (Power Rail)
- Voltage input 0 V ... -20 V
- Vibration sensor inputs
- Voltage/current field supply
- Voltage output 0 V ... -20 V
- Up to SIL 2 acc. to IEC/EN 61508



Function

This isolated barrier is used for intrinsic safety applications. It provides a floating output to power a vibration sensor (e. g., Bently Nevada) or accelerometer in a hazardous area and transfers the voltage signal from that sensor to the safe area. The device is designed to provide a voltage or current supply to the vibration sensor. Depending on connection the barrier provides 3.6 mA, 5.3 mA, or 8.9 mA supply current for 2-wire sensors, or 18 V at 20 mA for 3-wire sensors.

Connection

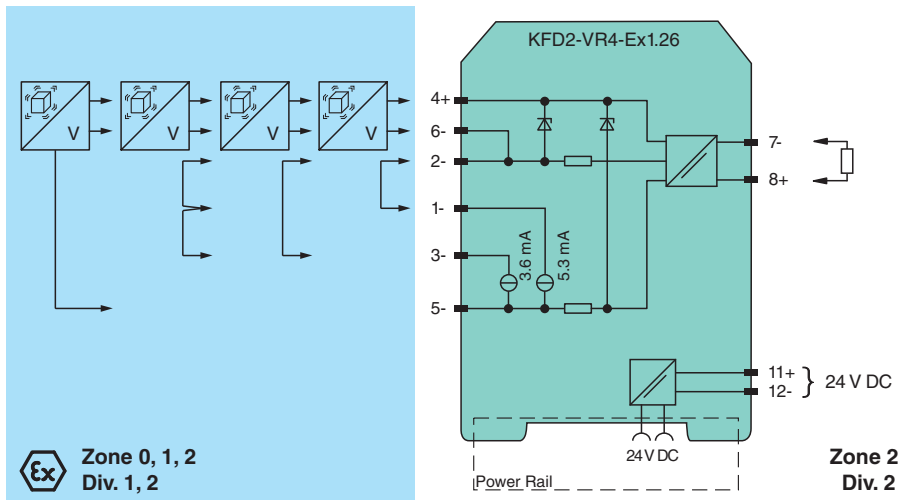

Technical Data

General specifications

Signal type Analog input

Functional safety related parameters

Safety Integrity Level (SIL) SIL 2

Supply

Connection Power Rail or terminals 11+, 12-

Rated voltage U_r 19 ... 30 V DC

Ripple within the supply tolerance

Power dissipation ≤ 1.2 W

Power consumption ≤ 1.6 W

Input

Release date: 2021-11-25 Date of issue: 2021-11-25 Filename: 70107327_eng.pdf

Refer to "General Notes Relating to Pepperl+Fuchs Product Information".

Pepperl+Fuchs Group
www.pepperl-fuchs.com

USA: +1 330 486 0002
pa-info@us.pepperl-fuchs.com

Germany: +49 621 776 2222
pa-info@de.pepperl-fuchs.com

Singapore: +65 6779 9091
pa-info@sg.pepperl-fuchs.com

PEPPERL+FUCHS

Technical Data

Connection side	field side
Connection	terminals 4 (common), 1, 3 and 5 (supply -), 2 and 6 (signal -)
Input resistance	10 k Ω terminals 4 (common), 6-/2-
Output rated operating current	terminals 4 (common), 5-: > 10 mA at -21 V or > 20 mA at -18 V terminals 4 (common), 1-: 5.3 mA \pm 0.4 mA at -10 V terminals 4 (common), 3-: 3.6 mA \pm 0.7 mA at -10 V, 20 °C (68 °F)
Transmission range	-20 ... 0 V
Output	
Connection side	control side
Connection	terminals 7-, 8+
Voltage	-20 ... 0 V
Load	\geq 9 k Ω (3-wire sensor), \geq 2 k Ω (2-wire sensor)
Output resistance	24 Ω typ., 27 Ω maximum Since this is much less than the end-to-end resistance of a zener barrier, it may be necessary to specify a monitor intended for use without a barrier. Please follow the advice of the monitor manufacturer.
Transfer characteristics	
Cut-off frequency	10 kHz (-0,1 dB) 20 kHz (-1 dB)
Deviation	DC transfer error (with 10 k Ω load) < 10mV
After calibration	additional error with AC superimposed is \pm 5 mV at 20 °C (68 °F) at any point within the span, provided that the alternating component of the input voltage is not excessive, e. g. - square waves (0 ... 20 kHz): 5 V _{pp} - sine waves (0 ... 20 kHz): the full span of 20 V _{pp} (= 100 g peak acceleration at 100 mV/g) is acceptable.
Influence of ambient temperature	(< 100 ppm of span)/K at any point within the span
Time delay relative to input	7.1 \pm 0.3 μ s
Ripple	in 200 kHz bandwidth < 20 mV _{rms} in 20 kHz bandwidth < 3 mV _{rms}
Galvanic isolation	
Output/power supply	functional insulation, rated insulation voltage 50 V AC
Indicators/settings	
Display elements	LED
Labeling	space for labeling at the front
Directive conformity	
Electromagnetic compatibility	
Directive 2014/30/EU	EN 61326-1:2013 (industrial locations)
Conformity	
Electromagnetic compatibility	NE 21:2017 EN IEC 61326-3-2:2018
Degree of protection	IEC 60529
Protection against electrical shock	UL 61010-1
Ambient conditions	
Ambient temperature	-20 ... 60 °C (-4 ... 140 °F)
Mechanical specifications	
Degree of protection	IP20
Connection	screw terminals
Mass	approx. 125 g
Dimensions	20 x 119 x 115 mm (0.8 x 4.7 x 4.5 inch) (W x H x D) , housing type B2
Mounting	on 35 mm DIN mounting rail acc. to EN 60715:2001
Data for application in connection with hazardous areas	
EU-type examination certificate	BAS 02 ATEX 7206
Marking	Ⓔ II (1)GD, [Ex ia Ga] IIC, [Ex ia Da] IIIC, (-20 °C \leq T _{amb} \leq 60 °C) [circuit(s) in zone 0/1/2]
Input	Ex ia Ga, Ex ia Da
Voltage	U _o -26.4 V
Current	I _o 90 mA

Release date: 2021-11-25 Date of issue: 2021-11-25 Filename: 70107327_eng.pdf

Technical Data





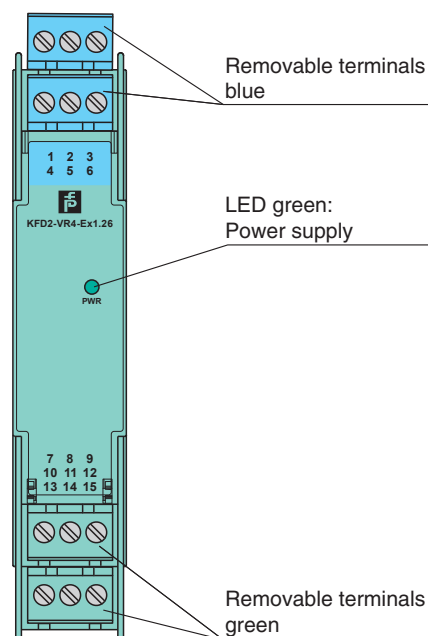

Power	P_o	570 mW
Supply		
Maximum safe voltage	U_m	253 V (Attention! The rated voltage can be lower.)
Output		
Maximum safe voltage	U_m	253 V (Attention! The rated voltage is lower.)
EU-type examination certificate		DMT 01 ATEX E 133
Marking		Ⓢ I (M1) [Ex ia] I
Certificate		TÜV 99 ATEX 1499 X
Marking		Ⓢ II 3G Ex nA II T4 [device in zone 2]
Galvanic isolation		
Input/Output		safe galvanic isolation acc. to IEC 60079-11, voltage peak value 375 V
Input/power supply		safe galvanic isolation acc. to IEC 60079-11, voltage peak value 375 V
Directive conformity		
Directive 2014/34/EU		EN 60079-0:2012+A11:2013 , EN 60079-11:2012 , EN 60079-15:2010 , EN 50303:2000
International approvals		
UL approval		
Control drawing		116-0316 (cULus)
IECEX approval		
IECEX certificate		IECEX BAS 05.0078 IECEX BAS 10.0085X
IECEX marking		[Ex ia Ga] IIC, [Ex ia Da] IIIC, [Ex ia Ma] I Ex nA II T4 Gc
General information		
Supplementary information		Observe the certificates, declarations of conformity, instruction manuals, and manuals where applicable. For information see www.pepperl-fuchs.com .

Assembly



Front view



Matching System Components

	KFD2-EB2	Power Feed Module
	UPR-03	Universal Power Rail with end caps and cover, 3 conductors, length: 2 m
	UPR-03-M	Universal Power Rail with end caps and cover, 3 conductors, length: 1,6 m
	UPR-03-S	Universal Power Rail with end caps and cover, 3 conductors, length: 0.8 m
	K-DUCT-BU	Profile rail, wiring comb field side, blue
	K-DUCT-BU-UPR-03	Profile rail with UPR-03- * insert, 3 conductors, wiring comb field side, blue

Accessories

	KF-ST-5GN	Terminal block for KF modules, 3-pin screw terminal, green
	KF-ST-5BU	Terminal block for KF modules, 3-pin screw terminal, blue
	KF-CP	Red coding pins, packaging unit: 20 x 6

Additional Information

Installation

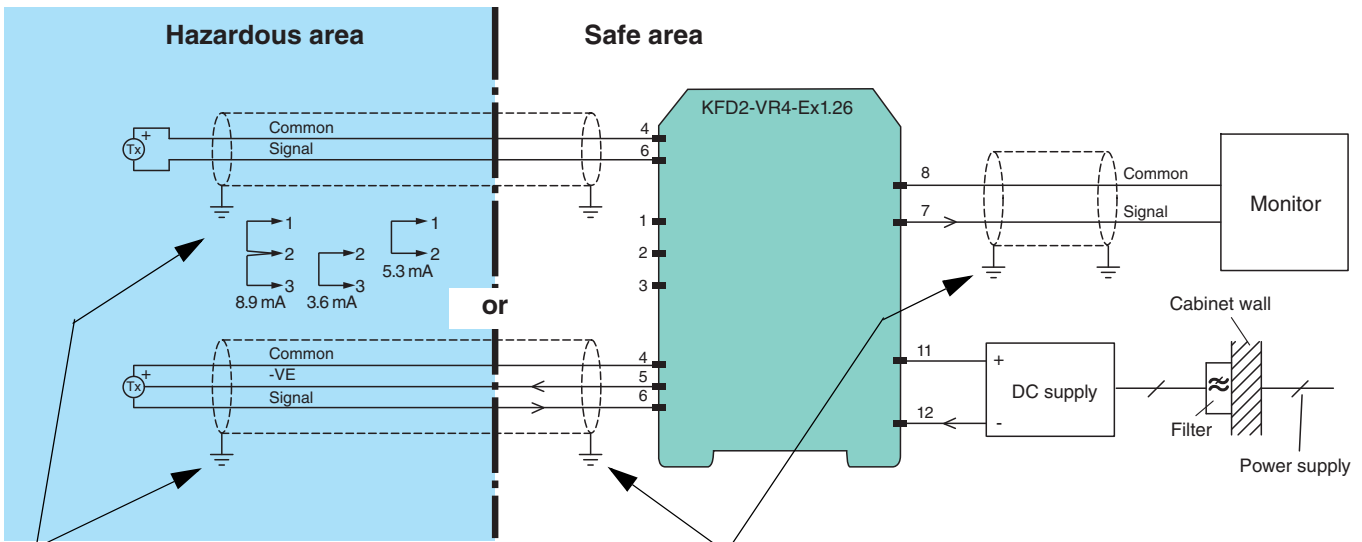

If the transducer and probe are isolated from ground, the cable screen may be left unconnected at this end but must be securely insulated. If the transducer circuitry is connected or decoupled to ground the screen must be securely grounded.

In general, please follow the recommendations of the transducer makers.

Cable screens should normally be grounded in the gland where the cable enters the barrier cabinet. If the cabinet doors are likely to be left open while transceivers are in use nearby, it is permissible to ground the cable screens to the DIN rail on which the barriers are mounted, but note that this may affect the R.F.I. immunity of other apparatus in the cabinet.

Function

Vibration monitoring sensors with 2-wire connection:

2-wire accelerometers and velocity indication devices are supplied with a fixed current and indicate what they are sensing by varying their own supply voltage - often by ± 5 V about a quiescent level of about 10 V. Those sensors are connected to terminals 4 and 6 with a link between terminals 2 and 1 (5.3 mA) or terminals 2 and 3 (3.6 mA) or terminals 2 and both 1 and 3 (8.9 mA).

The terminal 5 circuit has 2 constant sources of current connected to it which are brought out on terminals 1 at 5.3 mA and 3 at 3.6 mA. That means that a 1 k Ω resistor, for example, connected between terminals 4 and 1 would have 5.3 mA flowing in it, connected between terminals 4 and 3 would have 3.6 mA flowing in it and connected between terminals 4 and both 1 and 3 would have 8.9 mA flowing in it.

Example:

As an example, a 2-wire accelerometer requiring a minimum of 4 mA supply current and changing its own supply voltage by 100 mV for each "g" that it experiences would be connected between terminals 4 and 6 with a link between terminals 2 and 1. In that condition there may be around 10 V between terminals 4 and 6 under quiescent conditions. If it were capable of indication up to 50 g in each direction then the voltage between terminals 4 and 6 would vary between 5 V (indicating +50 g) and 15 V (indicating -50 g).

Vibration monitoring sensors with 3-wire connection:

Commonly 3-wire analogue proximity sensors are used to indicate shaft position and can "see" movements due to vibration which they indicate as a varying voltage level on the 3rd wire. Those sensors are connected to terminals 4, 5 and 6 with power supplied through terminals 4 and 5 and the signal connected to terminal 6. For a 3-wire sensor taking 10 mA, terminal 5 would be at approximately -21 V with respect to the common terminal 4 and the signal on the 3rd wire, connected to terminal 6, would be able to vary over the 0 to -19 V, or so, with respect to the common.

Terminal 4, the most positive terminal on the field side, is regarded as "common". There is an open circuit voltage of about 24 V DC between terminals 4 and 5 but terminal 5 has a resistance of about 300 Ω in series with it so the voltage falls to about 21 V at 10 mA and about 18 V at 20 mA. DC voltages at terminals 6 and 2 (referred to the "common") are repeated at terminal 7 using terminal 8 as the "common" on the safe side of the unit.

Release date: 2021-11-25 Date of issue: 2021-11-25 Filename: 70107327_eng.pdf